

DATASHEET

41E6PBT3SBM-VW

Pushbutton, 6 Amp Timer with BLE and ControlLink

Application

The pushbutton timer is a 3 wire, 6AX maximum rated time delay device with BLE (Bluetooth Low Energy) connectivity, suitable for controlling a huge range of electrical products. The tactile pushbutton has been designed to match other pushbutton devices in the range with respect to look and feel. A user menu access via the push button or the Wisier Room smartphone App allows for configuration of features such as LED indicator behaviour and time delay periods. When configuring with the Wisier Room App, delay periods from 1 second to 24 hours can be achieved with a 1 second resolution.

The pushbutton timer includes Clipsal's ControlLink technology that allows for multi-way triggering over conventional mains wiring. ControlLink also allows for multiple units to be connected to control larger individual loads.

Clipsal's simple momentary ControlLink switch (Cat No 41EPBM-VW) can be connected so that low cost multi-way triggering can be achieved without the need for expensive secondary switch mechanisms. ControlLink will also operate with conventional electro-mechanical momentary switches.

Features

- Delay timer, 1 second to 24 hour time delay (1 sec resolution)
- Configurable LED Indicator
- Configure from on-board menu via push button or using Wisier Room smartphone App
- ControlLink for multi-way triggering
- 6AX rated 240V latching relay contact (3 wire design)
- Comes with Vivid White (VW) push button assembly
- Fan run-on timer feature
- Installer restore feature (within Wisier Room App)
- Additional colour options through optional parts packs

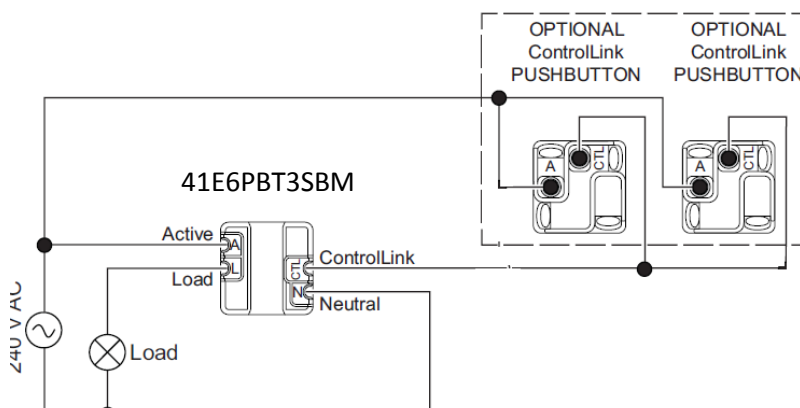

Wiring Diagram example: Remote triggering using 41EPBM mechs.

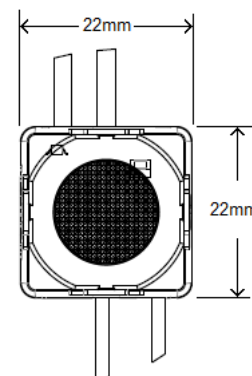
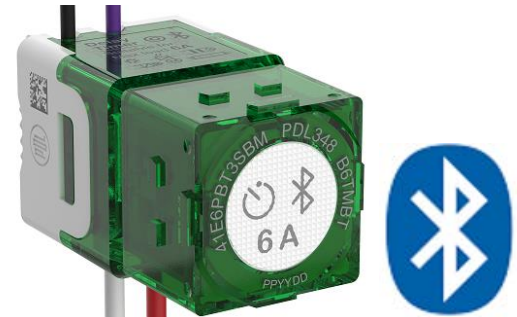

Allow a minimum 39mm depth in the wallbox / wall cavity to recess mechanisms and wiring.

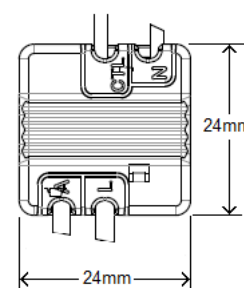
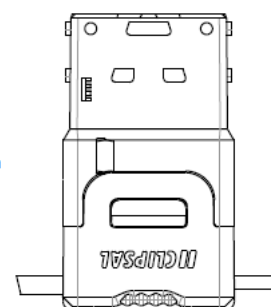
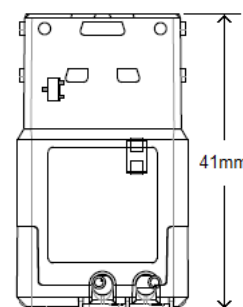
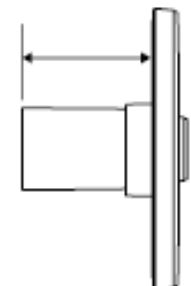

Life Is On

CLIPSAL
by Schneider Electric

Specifications

Operating Voltage:	220-240V ac 50Hz
Maximum Load:	6 AX, 6A inductive (0.8pf), motor – M30 (5A@0.5pf)
Minimum Load:	0 W (no minimum load)
Switching Technique:	Latching Relay (switched active output)
Operating Temperature:	0°-45° C
Storage Temperature:	0°-60° C
Ambient Operating & Storage Humidity:	5% ~ 90% Relative Humidity, Non-Condensing
Connection:	Flying Leads (Active, Neutral, Load, ControlLink) Length: 105mm
Configurable Time delay:	Via App: 1 second to 24 hours in 1 second increments Via Push button menu: 30s, 1m, 5m, 15m, 30m, 1h, 2h & 4hr
Fan Run On timer:	Activated via app: 1 second to 24hr Activated via Push button menu: 5 min preset.
LED Indicator:	Warm white, configurable modes
Multi-way Control:	Switching through ControlLink using conventional wiring
Plate Compatibility:	40 series mech compatible plates only (e.g. Iconic) . Not suitable for 30 series apertures.
App Details:	Clipsal Wisser Room (available from App store and Google play)
Compatible Smart devices:	All devices with Android v4.4 or IOS9 or above.
Wireless Technology:	Bluetooth Low Energy (BLE) , 2.4GHz. Point to Point only. Range: Approximately 10m indoors.
Installer Restore:	Configured within Wisser Room app, (Default Password – 1234)

Derating Details

Mechanisms per Plate	Maximum load per mechanism
1	6 A
2	4.5 A
3	4 A
4	3 A
5	2 A
6	1.5 A

Ordering details

Catalogue No.	Description
41E6PBT3SBM-VW	6 A Timer with ControlLink (Note – Supplied with VW Push button assembly)
Accessories	
40APB-VW	PB Mech Colour Cap- Vivid White (pk 5)
40APB-WY	PB Mech Colour Cap- Warm Grey (pk 5)
40APB-CY	PB Mech Colour Cap- Cool Grey (pk 5)
40APB-AN	PB Mech Colour Cap- Anthracite (pk 5)



40APB-VW

Life Is On

Schneider Electric (Australia) Pty Ltd

Contact us: clipsal.com/feedback

National Customer Care Enquiries:

Tel 1300 2025 25 Fax 1300 2025 56

New Zealand National Customer Care Enquiries:

Tel 0800 652 999 Fax 0800 101 152

Life Is On

CLIPSAL
by Schneider Electric

Schneider Electric (Australia) Pty Ltd reserves the right to change specifications, modify designs and discontinue items without incurring obligation and whilst every effort is made to ensure that descriptions, specifications and other information in this catalogue are correct, no warranty is given in respect thereof and the company shall not be liable for any error therein.

© 2015 Schneider Electric. All Rights Reserved.

Trademarks are owned by Schneider Electric Industries SAS or its affiliated companies.